

Starlet

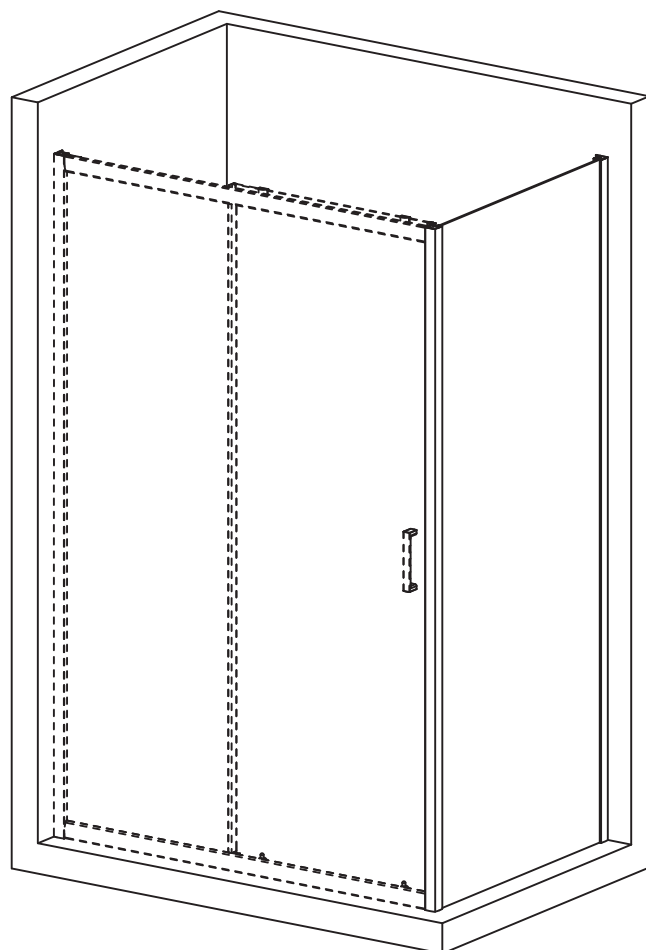

Side Panel









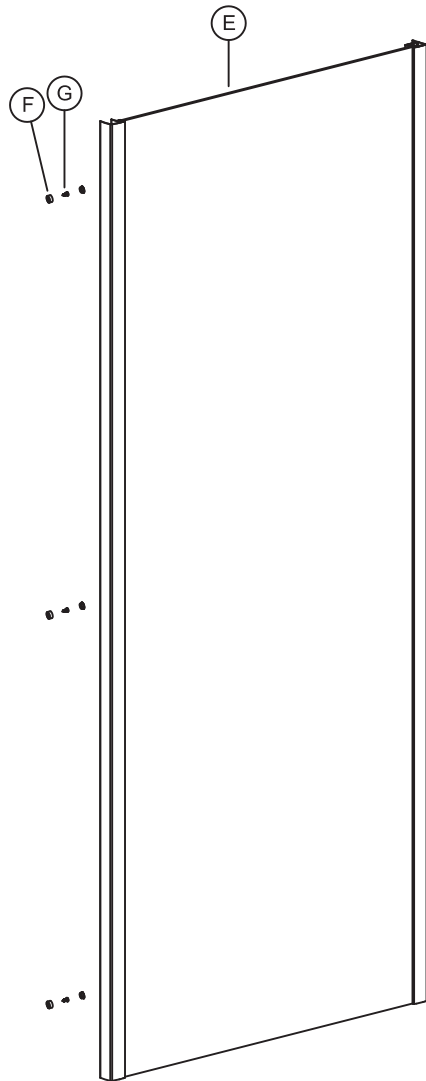

WARRANTY

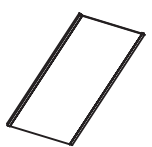

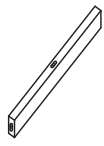
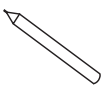
Αυτό το προϊόν είναι βαρύ και απαιτεί 2 ανθρώπους για την εγκατάστασή του.

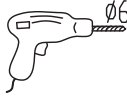



<p>E</p>  <p>X1</p>	<p>F</p>  <p>X3</p>	<p>G</p>  <p>ST3.5*9.5</p> <p>X3</p>						
				 <p>Ø6</p>		 <p>Ø2.8</p>		

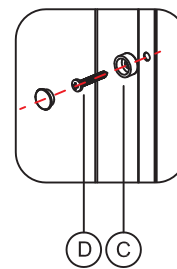
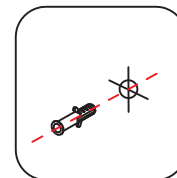
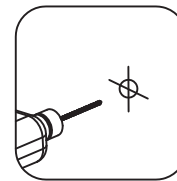
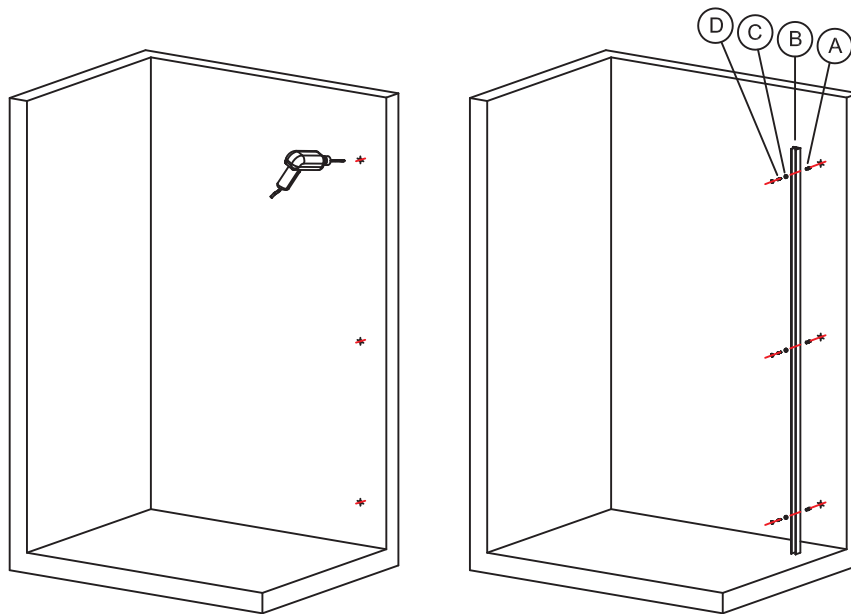
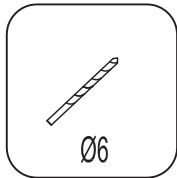
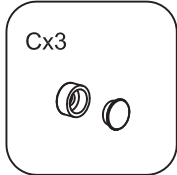
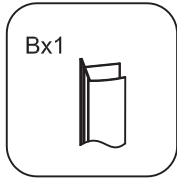
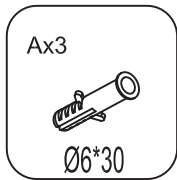

2

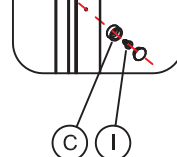
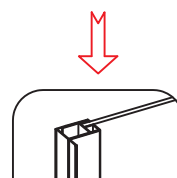
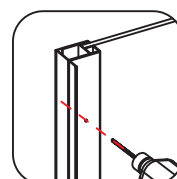
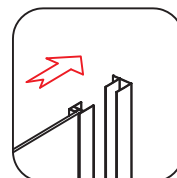
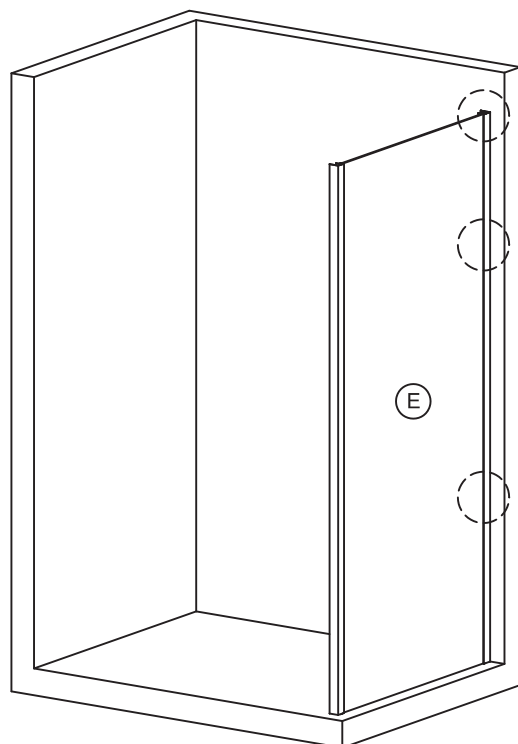
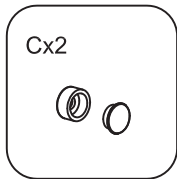
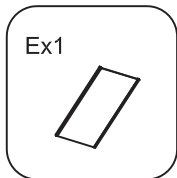

3

Fx3



Gx3



ST3.5*9.5



Ø2.8

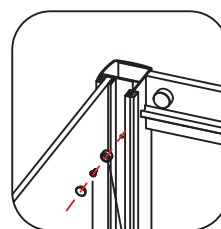
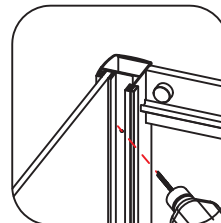
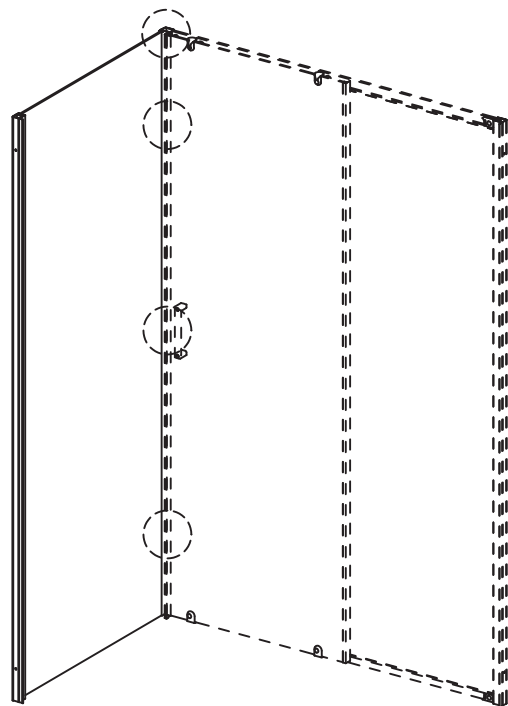
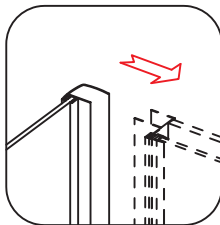

G F

4

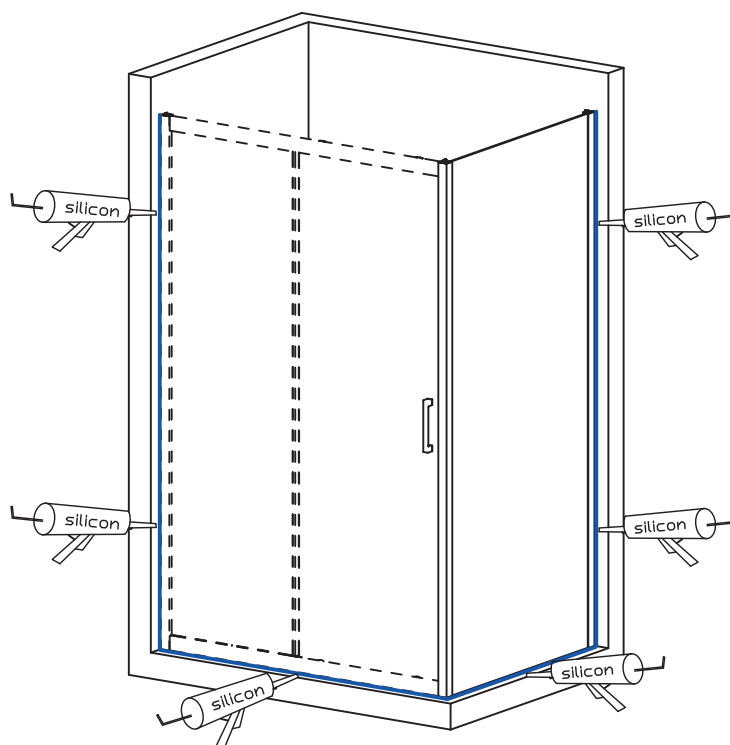

5