

Hotel collection

91645
Pedal bin 5 L

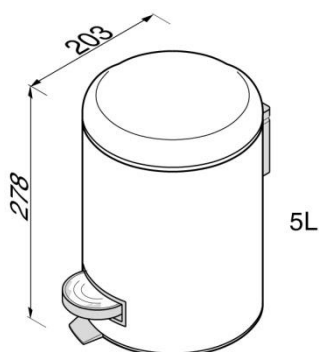

- Material: Stainless steel 410
- Finish: Polished
- Guarantee 5 years
- Soft Close
- Anti-Fingerprint coating
- Removable PP inner bin
- Free standing



- 278x203 mm

Also available:

91643 Pedal bin 3 L



91646 Square Pedal Bin, 6 L



Quality has proven to be of decisive importance in recent years, which is why we can offer a 12-year warranty period for our chrome products. The entire selection is developed in Amersfoort. Geesa is certified according to the ISO 9001-2008 standard for design, productions and the delivery of bathroom accessories. Geesa reserve the right to change product specification.

04/2017