

# E136005

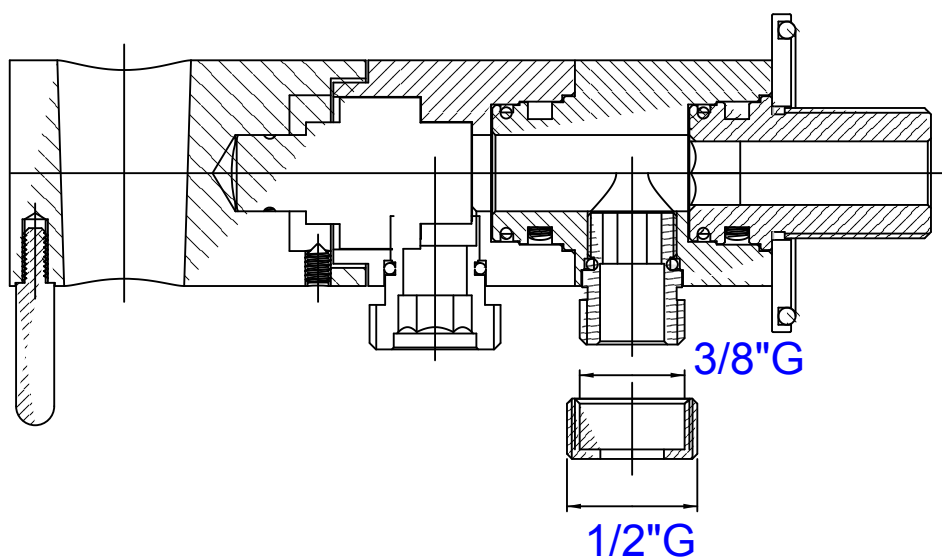

SHOWER  
SYSTEMS

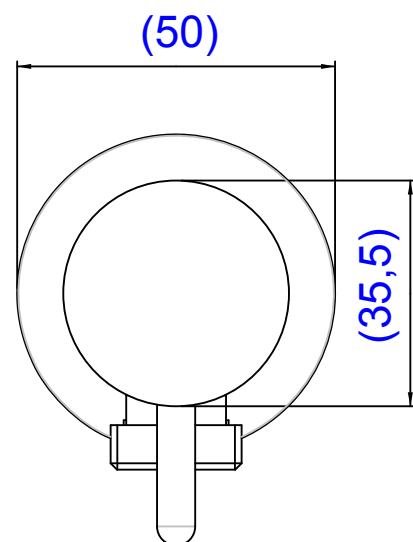

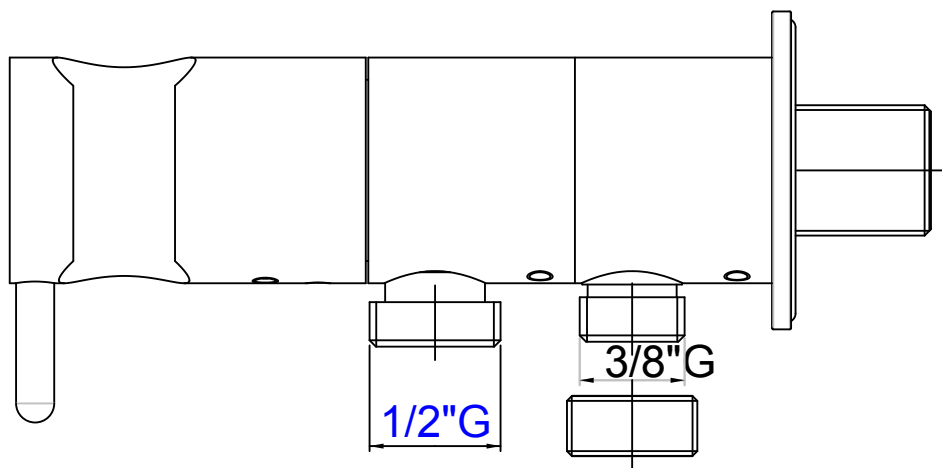
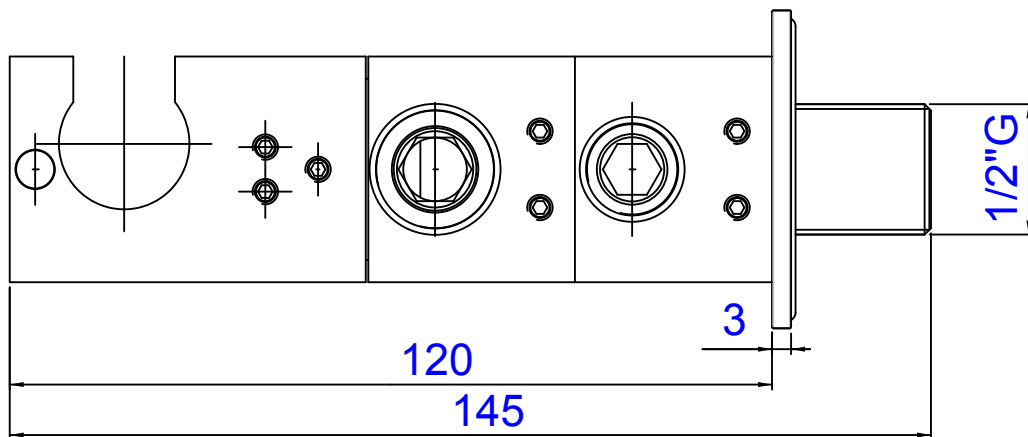
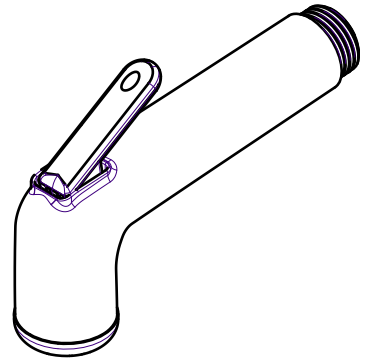
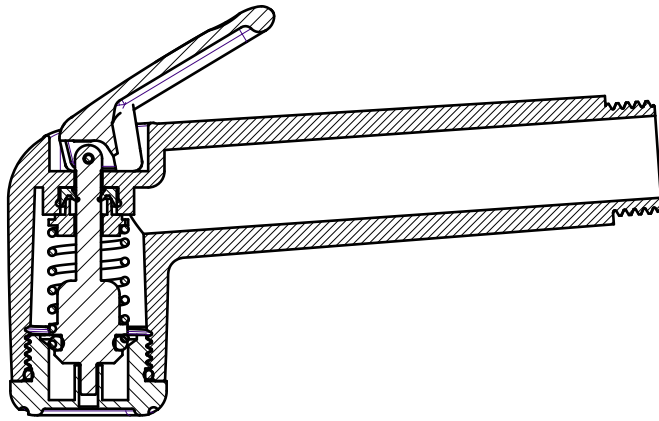

PART. SCALA 2:3

